

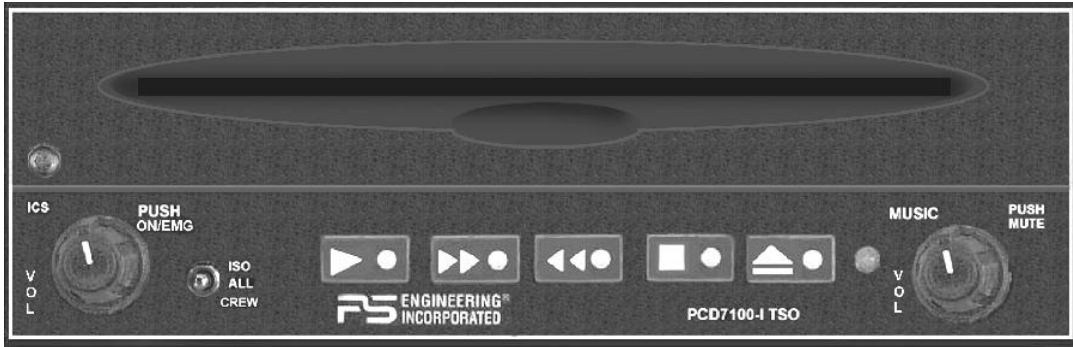

9800 Martel Road  
Lenoir City, TN 37772

**PCD7100**  
High-fidelity Stereo IntelliVox® Intercom  
System  
With integral music system  
FAA-TSO C50c  
US Patent 6,493,450



Document P/N 200-971-0006

Revision 8  
January 16, 2015

**Installation and Operation Manual**

**In certified aircraft, warranty is not valid unless this product is installed by an Authorized PS Engineering dealer.**

**PS Engineering, Inc. 2006 ©**  
*Copyright Notice*  
Any reproduction or retransmittal of this publication, or any portion thereof, without the expressed written permission of PS Engineering, Inc. is strictly prohibited. For further information contact the Publications Manager at PS Engineering, Inc., 9800 Martel Road, Lenoir City, TN 37772. Phone (865) 988-9800.

Table of Contents

<b><u>SECTION I GENERAL INFORMATION.....</u></b>	<b><u>1-1</u></b>
<b>1.1 INTRODUCTION.....</b>	<b>1-1</b>
<b>1.2 SCOPE .....</b>	<b>1-1</b>
<b>1.3 EQUIPMENT DESCRIPTION .....</b>	<b>1-1</b>
<b>1.4 APPROVAL BASIS .....</b>	<b>1-2</b>
<b>1.5 SPECIFICATIONS.....</b>	<b>1-2</b>
<b>1.6 EQUIPMENT SUPPLIED .....</b>	<b>1-3</b>
<b>1.7 EQUIPMENT REQUIRED BUT NOT SUPPLIED .....</b>	<b>1-3</b>
<b>1.8 LICENSE REQUIREMENTS .....</b>	<b>1-3</b>
<b><u>SECTION II - INSTALLATION.....</u></b>	<b><u>2-1</u></b>
<b>2.1 GENERAL INFORMATION .....</b>	<b>2-1</b>
2.1.1 SCOPE .....	2-1
<b>2.2 UNPACKING AND PRELIMINARY INSPECTION.....</b>	<b>2-1</b>
<b>2.3 EQUIPMENT INSTALLATION PROCEDURES .....</b>	<b>2-1</b>
2.3.1 COOLING REQUIREMENTS .....	2-1
2.3.2 MOUNTING REQUIREMENTS .....	2-1
2.3.3 MOUNTING RACK INSTALLATION .....	2-1
2.3.4 CONNECTOR ASSEMBLY .....	2-2
<b>2.4 CABLE HARNESS WIRING .....</b>	<b>2-2</b>
2.4.1 NOISE .....	2-2
2.4.2 POWER.....	2-2
2.4.3 COMMUNICATIONS PUSH-TO-TALK .....	2-2
2.4.4 BACKLIGHTING.....	2-3
2.4.5 INTERCOM WIRING (11950, 11951 ONLY) .....	2-3
2.4.6 PLAYBACK INSTALLATION (11951 ONLY).....	2-4
2.4.7 UNSWITCHED AUDIO INPUT (11950, 11951 ONLY).....	2-4
2.4.8 UNSWITCHED SUMMED AUDIO (11952, 11953 ONLY).....	2-4
2.4.9 AUDIO MESSAGE SYSTEM (11953 ONLY) .....	2-4
<b>2.5 ADJUSTMENTS.....</b>	<b>2-4</b>
<b>2.6 POST INSTALLATION CHECKOUT .....</b>	<b>2-5</b>
<b>2.7 UNIT INSTALLATION.....</b>	<b>2-5</b>
2.7.1 INTERCOM CHECKOUT (11950, 11951 ONLY) .....	2-5
2.7.2 CD PLAYER CHECKOUT .....	2-6
<b>2.8 INTERNAL RECORDER CHECKOUT (OPTIONAL) .....</b>	<b>2-6</b>
<b>2.9 FINAL INSPECTION.....</b>	<b>2-6</b>
<b><u>SECTION III OPERATION.....</u></b>	<b><u>3-1</u></b>
<b>3.1 SCOPE .....</b>	<b>3-1</b>
<b>3.2 POWER SWITCH (FAIL SAFE OPERATION).....</b>	<b>3-1</b>
<b>3.3 INTERCOM OPERATION.....</b>	<b>3-1</b>
3.3.1 INTERCOM VOLUME CONTROL .....	3-1
3.3.2 INTELLIVOX® VOX-SQUELCH .....	3-1
3.3.3 MUSIC 1 AND SOFT MUTE CONTROL .....	3-2
3.3.4 INTERCOM MODES .....	3-2
<b>3.4 OPERATING THE INTERNAL CD PLAYER .....</b>	<b>3-4</b>
<b>3.5 INTERNAL RECORDER SYSTEM (OPTIONAL) .....</b>	<b>3-4</b>

**PS Engineering**  
 PCD7100 Series Intercom System with Integral Music System  
 Installation and Operator's Manual

3.5.1 OPERATION..... 3-4

**3.6 PCD7100-P CD PLAYER ONLY (PART NUMBER 11952 AND 11953) ..... 3-5**

3.6.1 POWER/VOLUME KNOB..... 3-5

3.6.2 OPERATING THE INTERNAL CD PLAYER ..... 3-5

3.6.3 TONE CONTROL..... 3-5

3.6.4 AUDIO MESSAGING SYSTEM (11953 ONLY) ..... 3-5

**SECTION IV- WARRANTY AND SERVICE..... 4-1**

**4.1 WARRANTY ..... 4-1**

**4.2 FACTORY SERVICE ..... 4-1**

**APPENDIX A EXTERNAL PTT HOOK UP .....A**

**APPENDIX B – INSTALLATION DRAWING .....B**

**APPENDIX C CONNECTOR INTERCONNECT.....C**

**7.1 PCD7100 w/INTERCOM (11950, 11951) .....C**

**7.2 PCD7100 w/OUT INTERCOM (11952, 11953) .....B**

**APPENDIX D- INSTRUCTIONS FOR FAA FORM 337 AND CONTINUING AIRWORTHINESS .....D**

**8.1 INSTRUCTIONS FOR FAA FORM 337, PCD7100s.....D**

**8.2 INSTRUCTIONS FOR CONTINUING AIRWORTHINESS, PCD7100s.....D**

**APPENDIX E RTCA DO160D/EUROCAE ED-14D ENVIRONMENTAL QUALIFICATION FORM INTERCOM/CD PLAYER.....E**

Revision	Date	Reason
5	Jan 2003	Add MP3 Version
6	April 2006	Added compatability note
7	May 2008	Update installation kit description
8	January 2015	Removed reference to JTSO

## Section I GENERAL INFORMATION

### 1.1 INTRODUCTION

Quality cockpit and cabin entertainment has long been an elusive dream in general aviation. From marginal performance to unapproved parts, pilots couldn't enjoy the same music in their aircraft as they could in the family car.

The PCD7100-Series represents such a product. This one unit combines intercommunications and a compact disk player for ultimate functionality. Using proprietary *IntelliVox*® design, this intercom eliminates the requirements for intercom squelch adjustments. The CD player is designed for simple operation, avoiding any increase in cockpit workload from complicated controls.

Before installing and/or using this product, please read this manual completely. This will ensure that you will take full advantage of all the advanced features in the PCD7100.

### 1.2 SCOPE

This manual provides detailed installation and operation instructions for the PS Engineering PCD7100-series of CD Player/Intercom Systems. This includes the following units:

Model	Part Number	Description
PCD7100-I	11950	CD Player w/6-place ICS
PCD7100-I	11951	CD Player w/6-place ICS and /Internal Recorder
PCD7100-P	11952	CD Player only
PCD7100-P	11953	CD Player only w/Audio Warning System
PCD7100-P	11954	CD/MP3 Player Only w/Audio Warning System
PCD7100-I	11956	CD/MP3 Player w/6-place ICS
PCD7100-I	11957	CD/MP3 Player w/6-place ICS and /Internal Recorder
PCD7100-P	11958	CD/MP3 Player only

Where the functions are identical to all units, it will be referred to herein as a PCD7100. Otherwise, the applicable units will be specified.

### 1.3 EQUIPMENT DESCRIPTION

The PCD7100-series is a state of the art intercom with PS Engineering's proprietary *IntelliVox*® automatic voice activated (VOX) intercom system, that contains an integrated Compact Disk (CD) player.

A six-station voice activated (VOX) intercom is included in the PCD7100-I (p/n 11950, 11951, 11954, 11956). This system has PS Engineering's exclusive *IntelliVox*® circuitry that eliminates manual adjustments. The system contains six separate VOX mic circuits, and only opens the microphone channel in use.

The intercom system incorporates pilot isolate and crew modes.

There are two stereo music inputs with "Soft Mute." SoftMute is a circuit that automatically mutes the music during radio or intercom activity, and then slowly returns the music to full volume after the activity ceases.

Intercom control is through front panel-mounted volume knobs and 3-position mode switch. A single volume controls intercom level for the pilot and copilot. Passenger headphone volume is factory set, and adjusted in flight with headset-mounted volume controls. Passenger volume control is further adjustable through screwdriver access in the top of the unit. Intercom squelch is automatic.

## 1.4 APPROVAL BASIS

### TSO Approval.

The PCD7100, is FAA approved under TSO C50c (Audio Amplifiers), /DO-178B (*Software Considerations for Airborne Equipment*) and DO-214 (*Audio Systems Characteristics and Minimum Operational Performance Standards for Aircraft Audio Systems*).

All systems comply with relevant portions of EUROCAE ED-14D/DO-160D (*Environmental Conditions and Test Procedures for Airborne Equipment*), ED12B/DO-178B (*Software Considerations for Airborne Equipment*) and ED- 18/DO-214 (*Audio Systems Characteristics and Minimum Operational Performance Standards for Aircraft Audio Systems*).

Operation is subject to the following conditions: This device may not cause harmful interference. This device must accept any interference received, including interference that may cause undesired operation.

## 1.5 SPECIFICATIONS

<b>TSO COMPLIANCE</b>	
<i>Audio Selector/Intercom:</i>	C50c, Class A
APPLICABLE DOCUMENTS:	RTCA/DO-214 RTCA/DO-160D RTCA/DO-178B (Level E)
ENVIRONMENTAL Qualifications:	B1CABSRXXXXXXABBBBTMXXE2
<i>Temperature Range:</i>	
Operating:	-15° C to 55°C
Storage:	-40° C to 85°C
<i>Altitude:</i>	Up to 25,000 feet in a non-pressurized area of the cockpit.
DIMENSIONS:	Height: 2.0 in. (5.1 cm) Width: 6.25 in. (15.9 cm) Depth: 7.8 in. (19.8 cm)
WEIGHT (With Rack & Connectors):	2.2 lb. (1.0 kg)
<b>POWER REQUIREMENTS (Including Internal Lighting):</b>	
<i>Voltage:</i>	11 to 33 VDC
<i>Maximum Current:</i>	
11950, 11951	2.0 Amp (Externally protected by a 3 Amp pull type circuit breaker.
11952, 11953	1.5 Amp (Externally protected by a 2 Amp circuit pull-type breaker.)
<i>Typical operating current:</i>	800 mA
<b>Intercom Specifications</b>	
<i>Headphone Impedance:</i>	150 - 1000 Ω
<i>Headphone Output:</i>	35 mW each headset channel, no clipping <1% THD
<i>Microphone Impedance:</i>	150 - 600 Ω
<i>Intercom Positions (11950, 11951, 11954, 11956, 11957):</i>	6 places (with individual IntelliVOX circuits)
<i>Music Inputs:</i>	2 (Stereo)
<i>Music Muting:</i>	>-50 dB "Soft Mute" when Com or intercom active.
<i>Distortion:</i>	<1% THD @ 35 mW into 150Ω
<i>Mic Freq. Response, 3 dB:</i>	300 Hz - 6000 Hz
<i>Music Freq. Response, 3 dB:</i>	20 Hz -20 kHz

**1.6 EQUIPMENT SUPPLIED**

1 ea. of the following units:

Model	Part Number	Description
PCD7100-I	11950	CD w/6-place ICS
PCD7100-I	11951	CD w/6-place ICS w/IRS
PCD7100-P	11952	CD only
PCD7100-P	11953	CD only w/AWS
PCD7100-P	11954	CD/MP3 Player Only w/Audio Warning System
PCD7100-I	11956	CD/MP3 Player w/6-place ICS
PCD7100-I	11957	CD/MP3 Player w/6-place ICS and /Internal Recorder
PCD7100-P	11958	CD/MP3 Player only

PCD7100 Installation Kit: 250-971-0001 or 250-972-0400 as shown

Part Number	Description	250-971-0001 Unit Part Number 11950, 11951, 11953, 11954, 11956, 11957	250-972-0400 Unit Part Number 11952, 11958
120-430-9701	Tray	1	1
120-425-4402	44 Pin Connector Key 4/5	1	1
425-001-0002	Gold Plated Crimp Pins	35	10
475-440-0007	4-40x7/16" Phil-Pan w/Nylon Patch	2	2
475-630-0002	6-32 Clip Nut	6	6
<a href="#">475-632-0012</a>	6-32 x 1/2 Phil screw	6	6
200-971-00XX	Operator's and Installation Manual	1	1

**1.7 EQUIPMENT REQUIRED BUT NOT SUPPLIED**

- a) Circuit Breaker, PULL TYPE: 1 ea. 3 amp (11950, 11951, 11954, 11956, 11957) or 2 amp (11952, 11953, 11958)
- b) Headphone Jacks (Stereo, up to 6 as required)
- c) Microphone Jacks (up to 6 as required)
- d) Headphones, 150 Ω (Stereo), up to 6 as required
- e) Microphones, up to 6 as required
- f) Interconnect Wiring
- g) Intercom or audio system (11952, 11958, 11953, 11954)

**1.8 LICENSE REQUIREMENTS**

None

## **Section II - Installation**

### **2.1 GENERAL INFORMATION**

#### **2.1.1 SCOPE**

These sections provide detailed installation and interconnect instructions for the PCD7100-Series Intercom System with internal Compact Disc (CD) Player.

Please read this manual carefully before beginning any installation to prevent damage and post-installation problems. Installation of this equipment requires special tools and knowledge.

**NOTE:** An appropriately rated Certified Aircraft Repair Station must install this equipment in accordance with applicable regulations. PS Engineering, Incorporated warranty is not valid unless the equipment is installed by an authorized PS Engineering, Incorporated dealer. Failure to follow any of the installation instructions, or installation by a non-certified individual or agency will void the warranty, and may result in an unairworthy installation.

### **2.2 Unpacking and Preliminary Inspection**

Use care when unpacking the equipment. Inspect the units and parts supplied for visible signs of shipping damage. Examine the unit for loose or broken buttons, bent knobs, etc. Verify the correct quantity of components supplied with the list in Section 1.6 (B). If any claim is to be made, save the shipping material and contact the freight carrier. Do NOT return units damaged in shipping to PS Engineering. If the unit or accessories shows any sign of external shipping damage, contact PS Engineering to arrange for a replacement. Under no circumstances attempt to install a damaged unit in an aircraft. Equipment returned to PS Engineering for any other reason should be shipped in the original PS Engineering packaging, or other UPS approved packaging.

### **2.3 Equipment Installation Procedures**

#### **2.3.1 Cooling Requirements**

Forced air-cooling of the PCD7100 is not required. However the unit should be kept away from heat producing sources (i.e. defrost or heater ducts, dropping resistors, heat producing avionics) without adequate cooling air provided.

#### **2.3.2 Mounting Requirements**

The PCD7100 must be rigidly mounted to the instrument panel or other structure of the aircraft structure and within view and reach of the persons wishing access. Installation must comply with FAA Advisory Circular AC 43.13-2A (or later revision). The unit may be mounted in any area where adequate clearance for the unit and associated wiring bundle exist.

The unit must be installed within  $\pm 30^\circ$  of horizontal along the pitch axis, and  $\pm 10^\circ$  of horizontal along the roll axis in level flight.

Avoid installing the PCD7100 close to high current devices or systems with high-voltage, pulse type outputs, such as DME or transponders.

#### **2.3.3 Mounting Rack Installation**

Remove the unit from the mounting tray by unscrewing the 3/32" hex-head screw that is near the left edge of the unit. Carefully slide the unit free of the tray. Set the unit aside in a safe location until needed. Install the tray using six FHP 6-32 x 1/2" screws. The unit must be supported at front and rear of the mounting tray.

### **2.3.4 Connector Assembly**

The unit connector mates directly with the circuit boards in the PCD7100. The connector is a Molex crimp-type, and requires the use of a Molex hand crimp tool, EDP P/N 11-01-0203, CR6115B (or equiv.). The connector is mounted to the unit tray with #4-40 screws, from the inside of the tray. Ensure that proper strain relief and chafing precautions are made during wiring and installation.

### **2.4 Cable Harness Wiring**

Referring to the appropriate Appendix, assemble a wiring harness as required for the installation. All wires must be MIL-SPEC in accordance with current regulations. Two- and three-conductor shielded wire must be used where indicated, and be MIL-C-27500 or equivalent specification. Proper stripping, shielding and soldering technique must be used at all times. It is imperative that correct wire be used.

Refer to FAA Advisory Circular 43.13-2A for more information. Failure to use correct techniques may result in improper operation, electrical noise or unit failure. Damage caused by improper installation will void the PS Engineering warranty. PS Engineering can provide a custom made harness, visit [www.ps-engineering.com](http://www.ps-engineering.com) for more information.

#### **2.4.1 Noise**

Due to the variety and the high power of radio equipment often found in today's general aviation aircraft, there is a potential for both radiated and conducted noise interference.

The PCD7100 power supply is specifically designed to reduce conducted electrical noise on the aircraft power bus by at least 50dB. Although this is a large amount of attenuation, it may not eliminate all noise, particularly if the amplitude of noise is very high. There must be at least 12 VDC present at the connector pin 21, of the PCD7100 for the power supply to work in its designed regulation. Otherwise, it cannot adequately attenuate power line noise. Shielding can reduce or prevent radiated noise (i.e., beacon, electric gyros, switching power supplies, etc.) However, installation combinations can occur where interference is possible. The PCD7100 was designed in a RFI hardened chassis and has internal Electromagnetic Interference (EMI) filters on all inputs and outputs.

Ground loop noise occurs when there are two or more ground paths for the same signal (i.e., airframe and ground return wire). Large cyclic loads such as strobes, inverters, etc., can inject noise signals onto the airframe that are detected by the audio system. Follow the wiring diagram very carefully to help ensure a minimum of ground loop potential. Use only Mil Spec shielded wires (MIL-C-275000, or better).

Radiated signals can be a factor when low level microphone signals are "bundled" with current carrying power wires. Keep these cables physically separated. It is very important that you use insulated washers to isolate the ground return path from the airframe to **all** headphone and microphone jacks.

#### **2.4.2 Power**

The PCD7100-Series units are compatible with both 14 and 28 Volt DC systems. A three- (3) Amp PULL-TYPE circuit breaker is required for p/n 11950, 11951, or two (2) Amp PULL-TYPE breaker for p/n 11951, or 11952. Power and ground wires must be a twisted #18 AWG pair. Connect airframe power ground to Pin 22 only.

#### **2.4.3 Communications Push-to-Talk**

An important part of the standard intercom installation (11950, 11951) is the PTT (Push-To-Talk) switches that allow the use of your aircraft communications radio for transmissions. There are three typical configurations that can be used. Select the case that best fits the installation. Only the person who presses their PTT switch will be heard over the radio. If the pilot and copilot both use the PTT, the only pilot position has access to the radio. The pilot position will have PTT control regardless of the mic selector switch or copilot PTT when the PCD7100 is in the FAIL-SAFE mode.



*CASE I:* PTT is built into both pilot and copilot yokes.

*CASE II:* PTT is in pilot yoke only. This configuration requires a modified external PTT switch plugged into the copilot's microphone jack. (See Appendix A). When the copilot's PTT is pressed, the intercom switches the microphone audio from pilot to copilot mic.

*CASE III:* No built in PTT. This requires two built in PTTs to be installed, or modified external PTT switches to be used. Modify external PTT as required (See Appendix A).

No Push to Talk is required for CD-only (11952, 11953).

#### **2.4.4 Backlighting**

The PCD7100 has an automatic dimming of the pushbutton annunciator LEDs controlled by a photocell. A dimmer control allows the bezel text backlighting to be controlled by the aircraft dimmer. Connect the 14 V dimmer control to pin 1, the 28 V dimmer to pin A, as required.

#### **2.4.5 Intercom wiring (11950, 11951, 11956, 11957 only)**

See Appendix for intercom connection configurations. It is critical to the proper operation of this system to have this connector wiring made in accordance with these diagrams. Use 2- and 3-conductor, MIL-spec cable as shown. Connect the shields at the PCD7100 end only, and tie to the audio low inputs as shown.

**NOTE:** The harness can be custom made by PS Engineering, Inc. Simply call the factory or access [www.ps-engineering.com](http://www.ps-engineering.com) on the internet to obtain a wire harness work-sheet. The harness will be made to your specifications and fully functionally tested. All hardware is included.

##### 2.4.5.1 Entertainment 2 Input

**NOTE:** Use the low-level output of any entertainment device to connect to the PCD7100. Minimum of 1 VAC p-p, maximum signal level is **3 VAC** p-p.

**DO NOT** use a speaker-level output, this will cause internal damage in the PCD7100

An additional stereo entertainment device (CD player, cassette player, etc.) can be connected to the unit. Install a  $\frac{1}{8}$ -inch stereo jack in a convenient location so that the pilot can plug in the entertainment devices into the system. The audio signal at the entertainment input must be a minimum of 1 V P-P per channel for optimum music performance.

All *external* entertainment devices must be switched **off** for both takeoff and landing.

##### 2.4.5.1.1 Entertainment distribution

Entertainment source #1 (CD player) provides music for the pilot and copilot positions in crew mode and everybody in ALL. Entertainment source #2 provides music for the four passenger positions in crew mode only. The PCD7100-system incorporates a "Soft Mute" for the CD player. This will mute the music during ICS or radio conversation.

Entertainment inputs #1 and #2 can be paralleled (connected together) so the internal CD entertainment source can serve both the passengers and the crew. However, we suggest that a switch (DPDT) is installed between the single entertainment device and entertainment input #1 to allow entertainment flexibility.

**Caution:** Local oscillators and internal signals from some entertainment equipment can cause undesired interference with other aircraft systems. Before takeoff, operate the entertainment devices to determine if there is any adverse effect within the aircraft systems. If any unusual operation is noted in flight, immediately switch off the entertainment devices.

Both entertainment devices must be switched off for both takeoff and landing.

**2.4.6 Playback Installation (11951, 11957 only)**

To install the IRS, a momentary, normally open, push button switch is required. This switch can be located any where in cockpit convenient to the pilot's reach. The switch must be connected to pin Y of the PCD7100.

**2.4.7 Unswitched Audio Input (11950, 11951, 11956, 11957 only)**

The PCD7100-I has an audio input that is provided to the pilot headset. Pins 16 (right) and 18 (left) with respect to audio low (pin E) are presented to the pilot headset through an audio buffer.

**2.4.8 Unswitched Summed Audio (11952, 11953, 11954, 11958 only)**

PCD7100-P, player units have four audio inputs that are summed together and presented to the aural warning output, J1 pin 18 WRT V.

NOTE: These can be used to implement additional audio warnings when connected to the appropriate Unswitched audio input of an audio panel. This includes Autopilot warnings, TAWS, GPS alerts, Radio Altimeter, etc.

**2.4.9 Audio Message System (11953, 11954 only)**

The audio message installation requires inputs from an external annunciator, such as an Electronics International engine gage system. A falling edge (input pulled low) when applied to the appropriate pin of the connector will cause the message to be played, repeating every two seconds, until the acknowledge ("ACK") button is pushed.

Install the "ACK" button in a location convenient to the pilot and copilot position. This switch is a momentary SPST switch between Pin 4 and signal ground (18).

The following table contains information regarding various inputs.

Function	EGT or CHT	Fuel Flow or Level	Oil Pressure or temperature	Volt/ Amp	RPM	Manifold Pressure
PCD7100 Pin	5	8	6	9	7	10
Message Number	1	2	3	4	5	6
Message Text	"Check temperature"	"Check fuel"	"Check oil"	"Check battery"	"Check engine speed"	"Check boost"

Other combinations can be created at additional cost.

NOTE: PS Engineering can only provide input information at this time. **Approval basis is the responsibility of the installer.** Contact PS Engineering for more information.

**2.5 Adjustments**

The PCD7100 is factory adjusted to accommodate the typical requirements for most aircraft configurations. The only service adjustment is passenger headset volume control. These are set for maximum at the factory, but may be attenuated at installation if desired by accessing two adjustment pots.

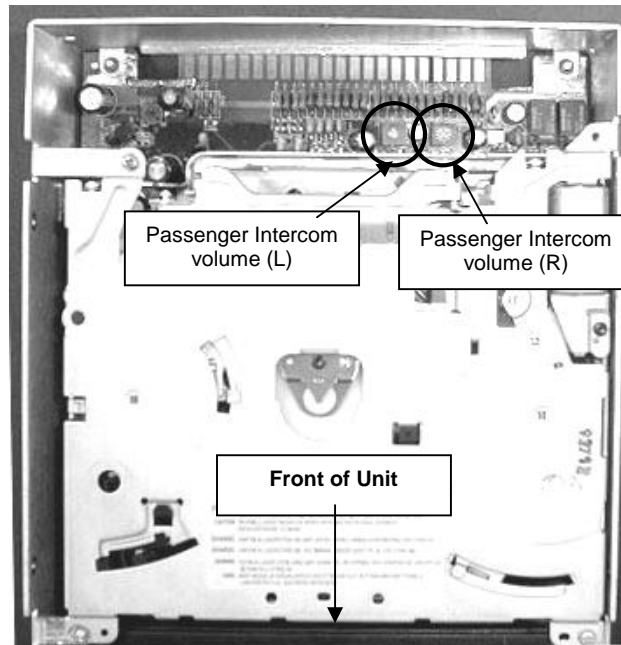

Figure 2-1- PCD7100 Adjustments

## 2.6 Post Installation Checkout

After wiring is complete, verify power is ONLY on pin 21 of the connector, and airframe ground on bottom connector pin 22. Failure to do so will cause serious internal damage and void PS Engineering's warranty.

## 2.7 Unit Installation

To install the PCD7100, gently slide the unit into the mounting rack until the hold-down screw is engaged. While applying gentle pressure to the face of the unit, tighten the 3/32" hex-head in the unit until it is secure. DO NOT OVER TIGHTEN.

**Warning:** Do not over-tighten the lock down screw while installing the unit in tray.  
**Internal damage will result.**



### 2.7.1 Intercom Checkout (11950, 11951, 11956, 11957)

1. Apply power to the aircraft and avionics. Leave PCD7100 off.
2. Plug headsets into the pilot, copilot, and occupied passenger positions.
3. Verify correct fail-safe operation by listening and transmitting on the aircraft radios in the pilot's headset with the unit off. The audio will only be presented to the pilot's right ear, in stereo mode.
4. Switch on the PCD7100. Verify that the STOP LED (Light Emitting Diode) shows green if there is a CD in the unit, or the Eject LED if there is not a CD inside.
5. Verify proper transmit and receive operation from the pilot and copilot positions, noting that the copilot PTT switch allows proper transmission on the selected transceiver.
6. Verify proper Intercom system operation in the **ALL**, **ISO** and **CREW** modes (see Table 3-1).

7. Verify that the PCD7100 system does not adversely affect any other aircraft system by systematically switching the unit on and off and changing modes, while monitoring the other avionics and electrical equipment on the aircraft.

### **2.7.2 CD Player Checkout**

8. Insert CD, and verify that the player accepts the disk with about ½ of the diameter in the unit. The player should pull the disk smoothly and drop into place.
9. The CD player will begin to play, automatically.
10. If the CD is inside at power-up, push the “play” button.
11. Verify that all CD modes operate.
12. Push the “Eject” button and verify that the disc is ejected within about 10 seconds.

### **2.8 Internal Recorder Checkout (Optional)**

With headset plugged into pilot's side jacks, tune aircraft radio to local frequency, such as FSS or ATC ground.

Select Com 1 on mic selector switch, and record at least five incoming radio transmissions.

This audio should only appear in one side of the pilot's headset, and it should be radio (or sidetone) traffic.

Depress the panel or yoke mounted playback switch, and verify that all five messages play, in the order received.

### **2.9 Final Inspection**

Verify that the wiring is bundled away from all controls and no part of the installation interferes with aircraft control operation. Move all controls through their full range while examining the installation to see that no mechanical interference exists. Verify that the cables are secured to the aircraft structure in accordance with good practices, with adequate strain relief. Ensure that there are no kinks or sharp bends in the cables and coaxial cables. Verify that the cables are not exposed to any sharp edges or rough surfaces, and that all contact points are protected from abrasion.

Complete logbook entry, FAA Form 337, weight and balance computation and other documentation as required. Sample text for FAA Form 337 and instructions for continuing airworthiness can be found in Appendix F.

Return completed warranty registration application to PS Engineering.

## Section III OPERATION

### GENERAL INFORMATION

#### 3.1 SCOPE

This section provides detailed operating instructions for the PS Engineering PCD7100-I, Intercom Systems with integrated Compact Disc (CD) player, and PCD7100-P, CD player only. Please read it carefully before using the equipment so that you can take full advantage of its capabilities.

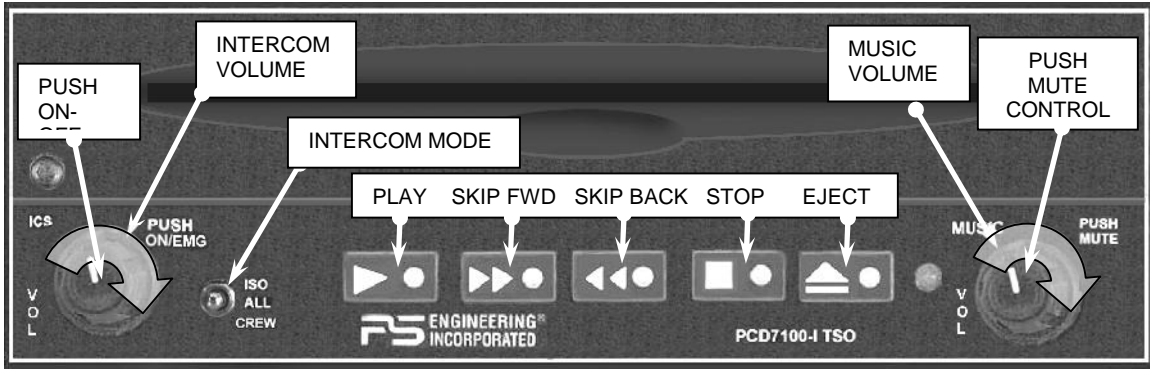

#### 3.3.1 Intercom Volume Control (11950, 11951, 11956, 11957)

The ICS volume control knob (left side) adjusts the loudness of the intercom for the pilot and copilot only. It has no effect on selected radio levels, music input levels or passengers' volume level.

Adjust the radios and intercom volume for a comfortable listening level for the pilot. Most general aviation headsets today have built-in volume controls; therefore, passenger volume can be adjusted at the headset.

#### 3.3.2 IntelliVox® VOX-Squelch

No adjustment of the *IntelliVox*® squelch control is necessary. Through independent signal processors on each microphone, the ambient noise appearing in all microphones is constantly being sampled. Non-voice signals are blocked. When someone speaks, only their microphone circuit opens, placing their voice on the intercom.

The system is designed to block continuous tones, therefore people humming or whistling in monotone may be blocked after a few moments.

For best performance, the headset microphone must be placed within ¼ inch of your lips, preferably against them. It is also a good idea to keep the microphone out of a direct wind path. Moving your head through a vent air stream may cause the *IntelliVox*® to open momentarily. This is normal.

For optimum microphone performance, PS Engineering, Inc. recommends installation of a Microphone Muff Kit from Oregon Aero (1-800-888-6910). This will not only optimize VOX performance, but will improve the overall clarity of all your communications.

**Table 3-1 Mic Muff® Part Numbers**

<b>Manufacturer</b>	<b>Model</b>	<b>Mic Muff® Part Number</b>
Bose	Dynamic	90010
	Electret	90015
	M87 Dynamic	90020
David Clark	H10-30	90010
	H10-20, H10-40	90015
	H10-13.4	90015
Lightspeed	15K & 20K	90015
Peltor	7003	90010
	7004	90015
Pilot	11-20 & 11-90	90015
Sennheiser		90015
Telex	Airman 750	90015
	AIR3000	90010

### 3.3.3 Music 1 and Soft Mute Control

The right-side volume knob controls the loudness of the internal CD player.

The volume knob controls the music volume only, it has no effect on the intercom or radio volume, or the secondary music input level.

This knob is also the Soft Mute control for the CD player. Normally, the music is instantly muted during radio or intercom conversation, and returns gradually to full volume when conversation stops. Pushing the knob once will inhibit the soft mute, enabling a “Karoake” mode, where the music remains at the normal level for a sing-along. Push again to return to a soft muting mode.

#### 3.3.3.1 Mono headsets in Stereo Installation

Plugging a mono headset into the pilot or copilot jacks has no effect other than there will be no stereo left and right separation. Since all passenger headsets are connected in parallel, if a monaural headset is plugged in to a PCD7100 Stereo installation, one channel will be shorted. Although no damage to the unit will occur, all stereo-equipped passengers will lose one channel. PS Engineering modifies headsets to add stereo capability, using high-fidelity speakers. Contact factory for details (865-988-9800 or [www.ps-engineering.com](http://www.ps-engineering.com)).

### 3.3.4 Intercom Modes

On the left side of the intercom-versions is a 3-position mode switch that allows the pilot to tailor the intercom function to best meet the current cockpit situation.

**ISO:** (Up Position): The pilot is isolated from the intercom and is connected only to the aircraft radio system. He will hear the aircraft radio reception (and sidetone during radio transmissions). Copilot and passengers will hear intercom and CD player. Neither will hear aircraft radio receptions or pilot transmissions.

**ALL: (Middle Position):** All parties will hear the aircraft radio, CD music and intercom. During any radio or intercom communications, the music volume automatically decreases (unless the mute is inhibited). The music volume will gradually return to the original level after communications have been completed.

**CREW (Down Position):** Pilot and copilot are connected on one intercom channel and have exclusive access to the aircraft radios. They may also listen to CD music. Passengers can continue to communicate with themselves without interrupting the Crew and also may listen to Entertainment 2. Entertainment 2 may be connected to the CD player during installation if so desired.

### 3.3.4.1 Soft Mute and Soft Mute inhibit

The Soft Mute feature assures that the aircraft radio transmissions will not be missed due to entertainment playing. When there is radio reception or intercom conversation, the music level is dropped to a low, or background level. When the radio or intercom traffic ceases, the level gradually returns to normal.

The front panel "MUTE" switch controls muting of the CD player. Pushing the music volume knob places the ICS in Karaoke (or sing along) mode, which inhibits the soft mute feature. This allows the music to continue uninterrupted by intercom or radio traffic when cockpit workload is appropriate. Pushing the knob again will release the mute inhibit function.

**Table 3-2 Intercom Modes**

Mode	Pilot Hears	Copilot Hears	Passenger Hears	Comments
<b>Isolate</b>	A/C Radios Pilot Sidetone (during radio transmission) CD is Muted	Copilot and passenger intercom CD player	Passenger and Copilot intercom CD Player	This mode allows the pilot to communicate without the others bothered by the conversations. Copilot and passengers can continue to communicate and listen to music
<b>All</b>	Pilot Copilot A/C Radio Passengers CD player	Copilot Pilot A/C Radio Passengers CD player	Passengers Pilot Copilot A/C Radio CD player	This mode allows all on board to hear radio reception as well as communicate on the intercom. Music is muted during intercom and radio communications
<b>Crew</b>	Pilot Copilot A/C Radio CD Player	Copilot Pilot A/C Radio CD Player	Passengers Entertainment #2*	This mode allows the pilot and copilot to concentrate on flying, while the passengers can communicate amongst themselves. Two separate music inputs are possible.

### 3.3.4.2 Secondary Entertainment Input

The PCD7100 has provisions for an additional entertainment input. The primary music volume control does not affect secondary music level.

While in the CREW mode, pilot and copilot will hear entertainment input #1 while the passengers may listen to entertainment input #2.

It is also possible to use only one entertainment input device for both entertainment inputs. It is suggested however, that a switch (DPDT) is installed between the single entertainment device and entertainment input #1. This will allow the passengers to play the CD while in the Crew mode.

### **3.4 Operating the internal disc Player**

The single-disk CD player is designed for simple operation. There are five buttons with the following functions.

- (Play) Plays disc, push again to pause
- (Jump Forward) Push to jump to the next track, hold to fast forward in current track
- (Jump Backward) Push to jump to the previous track, hold to rewind in current track
- (Stop) Stops playback
- (Eject) Ejects disc

The CD player will begin to play automatically when a CD is inserted. Press the play button to pause the track.

The jump forward button advances to the next track. Jump backwards selects the previous track.

On MP3 units (11954, 11956, 11957, 11958), pressing the Jump Forward and Jump Backward buttons at the same time will toggle the unit into a random play mode. Random Mode is particularly useful if the disc contains a large number of files.

Stop ceases play, and Eject removes the disk from the CD player.

### **3.5 Internal Recorder System (Optional)**

The Intercom Recording System (referred to here as the IRS) is a digital recording system allowing automatic storage and immediate playback of all incoming aircraft radio receptions.

Operating as a continuous loop recorder, (first message received will be the last heard), the recorder has one minute of recording time divided into as many as 16 messages. With its own built-in VOX circuit, there are no buttons to press to start recording. The system automatically begins to record the instant the radio becomes active. Only aircraft radio audio in pilot's headset is recorded and only the pilot will hear the playback audio, in one ear.

#### **3.5.1 Operation**

Recording is automatic; there is no action required by the pilot. To play back the last recorded message, simply press the momentary switch associated with the IRS. Each additional press of the button will play the preceding recorded message.

To stop playback, hold the playback button for two seconds. The next push will then play the prior message.



### 3.6 PCD7100-P CD Player Only (Part Number 11952, 11953, 11958 and 11959)

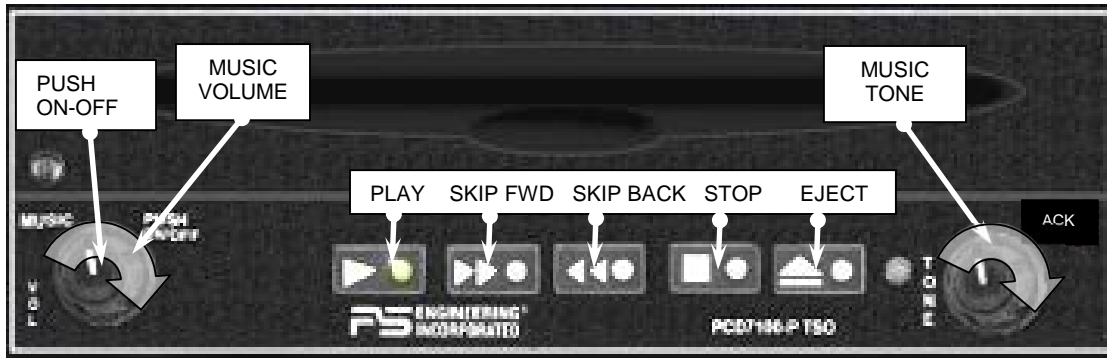

#### 3.6.1 Power/Volume Knob

Pushing the right-hand knob switches the PCD7100-P on. Push again to turn off. Rotate the knob to increase volume on the music output.

#### 3.6.2 Operating the internal CD Player

The single-disk CD player is designed for simple operation. There are five buttons with the following functions.

- ▶ (Play) Plays CD, push again to pause
- ▶▶ (Jump Forward) Push to jump to the next track, hold to fast forward in current track
- ◀◀ (Jump Backward) Push to jump to the previous track, hold to rewind in current track
- (Stop) Stops playback
- (Eject) Ejects disc

The CD player will begin to play automatically when a CD is inserted. Press the play button to pause the track.

The jump forward button advances to the next track. Jump backwards selects the previous track.

On MP3 units (11954, 11956, 11957, 11958), pressing the Jump Forward and Jump Backward buttons at the same time will toggle the unit into a random play mode. Random Mode is particularly useful if the disc contains a large number of files.

Stop ceases play, and Eject removes the disk from the CD player.

#### 3.6.3 Tone Control

Turning the left-hand knob modifies the bass/treble of the music output to suit individual tastes.

#### 3.6.4 Audio Messaging system (11953 and 11954 only)

When this option is installed, the PCD7100-P contains six stored messages. An outside annunciator, such as an Electronics International engine gage system triggers these messages. When there is an announcement, it will be repeated every two seconds until the remote-mounted ACK button is pushed. This stops the played annunciation, until the next announcement is required (the next falling edge).

#### 3.6.4.1 Push ACK (11953, 11954 only)

Pushing the left-hand will acknowledge and silence a playing Aural Warning, if this feature is implemented (Part number 11953 only).

### **3.7 Creating MP3s from an Audio CD**

1. Start MusicMatch JukeBox. ([www.musicmatch.com](http://www.musicmatch.com)) Press the recorder button, which is the small red dot located in the top right corner. This will open the recorder window located at the bottom of the screen.
2. Insert an audio CD into the CD drive. MusicMatch will automatically read the disc and display the contents in the recorder window. Press the REFRESH button to check the Internet database for CD information, such as artist, song title, or album. If this information is available, it will automatically be updated in the file.
3. Select Options->Recorder->Format and select either MP3 or MP3PRO format. You may also set the MP3 file quality under the Options->Recorder->Quality menu.
4. Select the tracks to be copied to MusicMatch by checking the box next to the desired track. Press the record button in the lower left corner when complete
5. MusicMatch will then convert the files from the audio CD to MP3 and display them in the Music Library box located in the middle of the screen
6. To edit the MP3 information, select a file in the Music Library and press the TAG button in the top right corner of the Music Library box. This will display the MP3 tagged information screen. Select the General tab to show the information that can be modified for the PXE7300.
7. The PXE7300 can display song name, artist, album, and filename. This corresponds to the Track title, Artist, Album, and Track Filename fields shown on the screen. Each of these fields can be modified to the user's preference. Note: The PXE7300 is limited to displaying up to 22 characters in each of these fields. Click on the appropriate field to modify the track title, artist, or album. To modify the filename, select the Rename Files button in the lower left corner. Click on the field labeled New File Name and press OK to change the file name. Press the Apply and OK buttons to update the information

## **Section IV- Warranty and Service**

### **4.1     Warranty**

In order for the factory warranty to be valid, the installations in a certified aircraft must be accomplished by an FAA-certified avionics shop and authorized PS Engineering dealer. If the unit is being installed by a non-certified individual in an experimental aircraft, a factory-made harness must be used for the warranty to be valid.

PS Engineering, Inc. warrants this product to be free from defect in material and workmanship for a period of one (1) year from the date of installation as recorded in aircraft logbook and/or on FAA Form 337. During the **twelve (12) months**, PS Engineering, Inc., at its option, will send a replacement unit at our expense if the unit should be determined to be defective after consultation with a factory technician.

All transportation charges for returning the defective units are the responsibility of the purchaser. All domestic transportation charges for returning the exchange or repaired unit to the purchaser will be borne by PS Engineering, Inc. The risk of loss or damage to the product is borne by the party making the shipment, unless the purchaser requests a specific method of shipment. In this case, the purchaser assumes the risk of loss.

This warranty is not transferable. Any implied warranties expire at the expiration date of this warranty. PS Engineering **SHALL NOT BE LIABLE FOR INCIDENTAL OR CONSEQUENTIAL DAMAGES**. This warranty does not cover a defect that has resulted from improper handling, storage or preservation, or unreasonable use or maintenance as determined by us. This warranty is void if there is any attempt to disassemble this product without factory authorization. This warranty gives you specific legal rights, and you may also have other rights, which may vary from state to state. Some states do not allow the exclusion of limitation of incidental or consequential damages, so the above limitation or exclusions may not apply to you.

All items repaired or replaced under this warranty are warranted for the remainder of the original warranty period. PS Engineering, Inc. reserves the rights to make modifications or improvements to the product without obligation to perform like modifications or improvements to previously manufactured products.

### **4.2     Factory Service**

The unit is covered by a one-year limited warranty. See warranty information. Call PS Engineering, Inc. at (865) 988-9800 before you return the unit. This will allow the service technician to provide any other suggestions for identifying the problem and recommend possible solutions.

After discussing the problem with the technician and you obtain a Return Authorization Number, ship product to:

PS Engineering, Inc.  
Attn: Service Department  
9800 Martel Rd  
Lenoir City, TN 37772  
(865) 988-9800   FAX (865) 988-6619

Email: support@ps-engineering.com

**NOTE: PS Engineering will not be responsible for any units shipped in the U. S. Mail.**

**Units received without either a Return Authorization or a contact telephone number will be refused and returned to the sender.**

## **Appendix A External PTT Hook Up**

This section applies to PCD7100-I units (with internal intercom). Part of the installation includes the installation of PTT (Push To Talk) switches that allow the use of your aircraft radio for communications transmissions.

There are three configurations that can be used, you must select the case that best fits your installation. NOTE: Only the person who presses their PTT switch will be heard over the radio.

### **CASE I**

*The PTT is built into the pilot and copilot yokes*

Simply install the plugs from the headset into the aircraft headphone jacks. Then use the yoke mounted PTT to transmit. No other action is required.

### **CASE II**

*Built in PTT only on the pilot side only*

This configuration requires a modified external PTT switch plugged into the copilot's mic jack. (See Details Below) When the copilot's PTT is depressed, this activates an internal relay that switches the mic audio to the aircraft radio from the pilot to the copilot.

### *Case III*

*No built in PTT switch at all.*

Two built-in PTT must be installed, or two external, modified PTT switches will be required for both the pilot and copilot. Modifications to the PTT are required. (See details below)

<b>Push To Talk Modifications</b>
-----------------------------------

When received from the manufacturer, an after-market PTT switch opens the mic audio path to the "ring" connection of the PTT mic plug until the button is pressed. When the PTT is between the intercom and the headset, the intercom function will not work unless the PTT switch is depressed. A simple modification can be performed to allow proper intercom operation. NOTE: This mod does not alter normal operation.

Below are some examples of typical modifications. Contact PS Engineering or the PTT manufacturer for more details if necessary.

#### **Procedures For David Clark PTT**

Unscrew the round black plastic cover from the jack.  
Connect the joined black wires to the red wire.  
Replace the round black plastic cover.

#### **Procedures for Telex PT-200**

Unscrew the round black plastic cover from the jack.  
Cut the red wire in the middle of the wire.  
Strip both ends of the insulation.  
Solder the two ends to the ground lug to the PTT jack.  
Replace the round black plastic cover.

#### **Procedures for Telex PT-300**

Unscrew the round black plastic cover from the plug jack.  
Remove the heat shrink material from the joined black wires.  
Solder these two wires to the lug that has a white wire already soldered to it.  
Replace the round black plastic cover

**Appendix B – Installation Drawing**

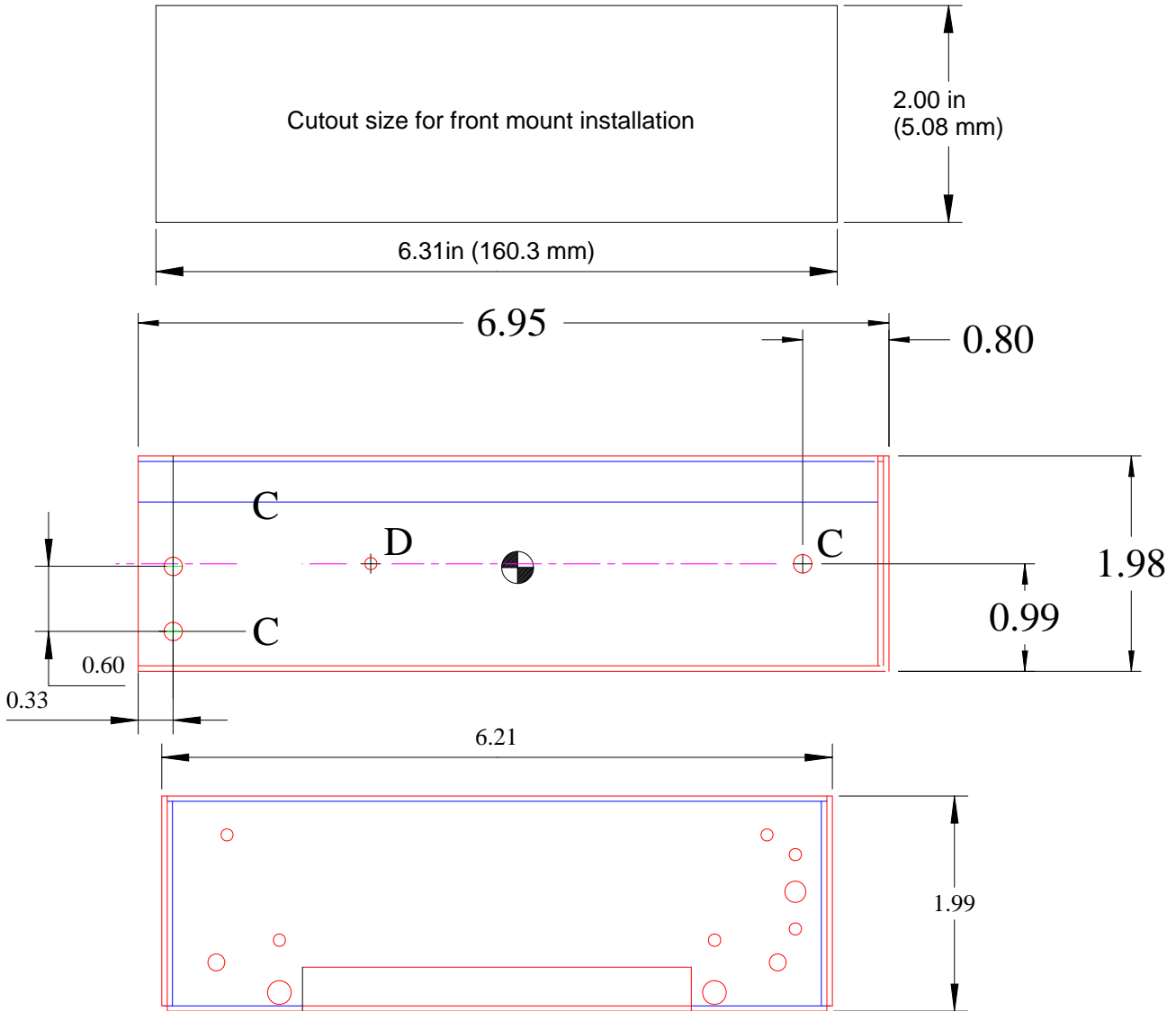

Weight: 2.2 lb with tray and connectors ( 1.0 kg)

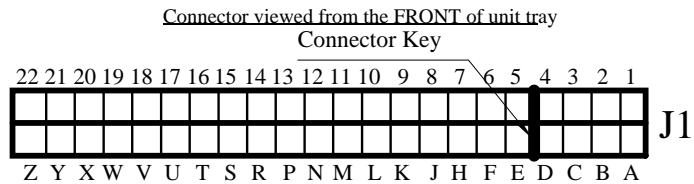
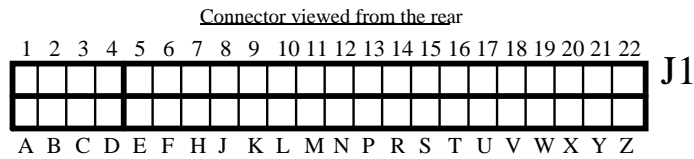

## Appendix C Connector Interconnect

### 7.1 PCD7100 w/Intercom (11950, 11951, 11956, 11957)

PCD7100 J1 CONNECTOR

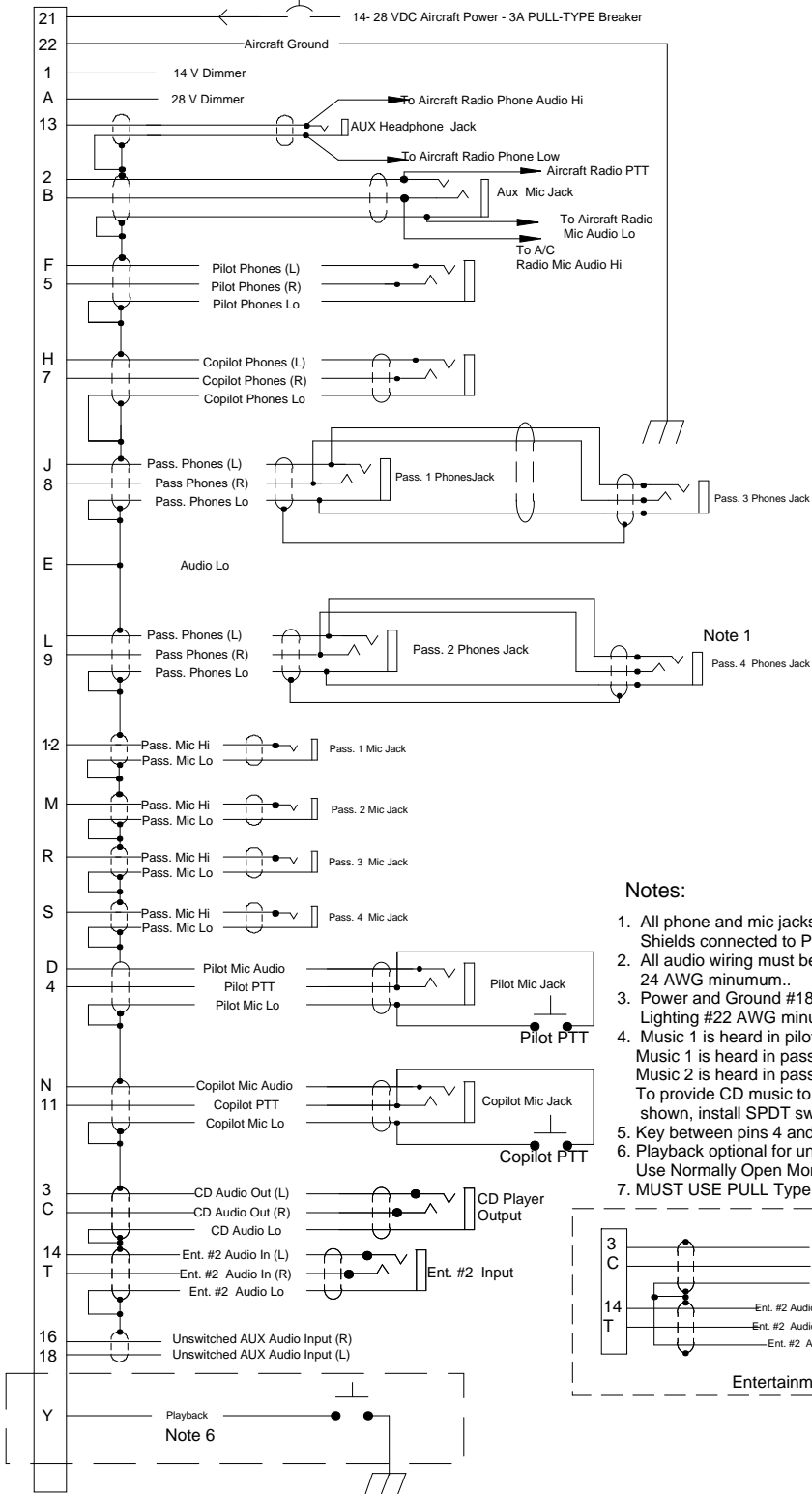

**Notes:**

1. All phone and mic jacks must be floating from ground. Shields connected to PCD7100 only.
2. All audio wiring must be MIL 22750 or 27500 24 AWG minimum.
3. Power and Ground #18AWG Mil-Spec Tefzel minimum. Lighting #22 AWG minium.
4. Music 1 is heard in pilot and copilot positions in ALL and Crew mode. Music 1 is heard in passenger positions in ALL mode. Music 2 is heard in passenger positions only in crew mode. To provide CD music to passengers in all modes, loop back as shown, install SPDT switch to control distribution if desired.
5. Key between pins 4 and 5.
6. Playback optional for units with internal recorder. Use Normally Open Momentary switch.
7. MUST USE PULL Type circuit breaker

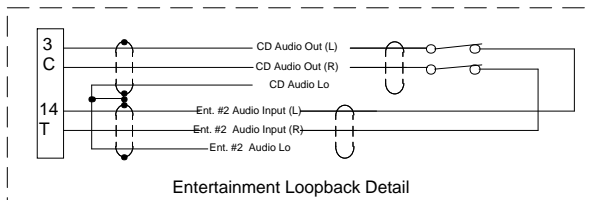

**7.2 PCD7100 w/out Intercom (11952, 11953, 11954, 11958)**

**PCD7100-P J1 CONNECTOR**

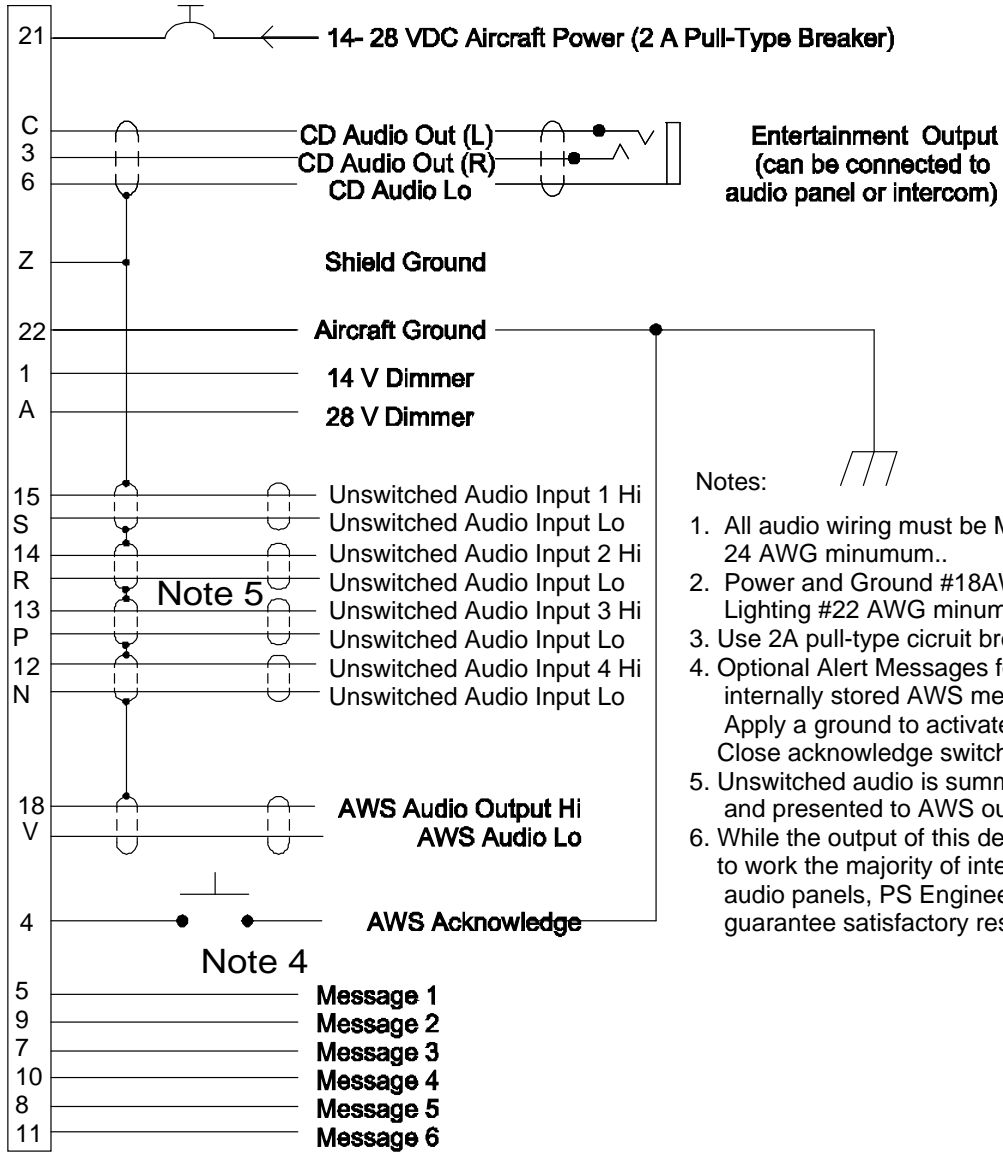

- Notes:
1. All audio wiring must be MIL 22750 or 27500 24 AWG minimum..
  2. Power and Ground #18AWG Mil-Spec Tefzel minimum. Lighting #22 AWG minum.
  3. Use 2A pull-type circuit breaker.
  4. Optional Alert Messages for units with internally stored AWS messages. Apply a ground to activate the specific message. Close acknowledge switch to cancel.
  5. Unswitched audio is summed and presented to AWS output.
  6. While the output of this device is designed to work the majority of intercoms and audio panels, PS Engineering can not guarantee satisfactory results for all devices.

## Appendix D- Instructions for FAA Form 337 and continuing airworthiness

### 8.1 Instructions for FAA Form 337, PCD7100s

One method of airworthiness approval is through an FAA Form 337, *Major Repair and Alteration (Airframe, Powerplant, Propeller, or Appliance)*. In the case of the PCD7100, you may use the following text as a guide.

Installed audio selector and 6-place intercom, PS Engineering PCD7100, part number 1195 (X) in (location) at station     . Installed per AC43.13-2, Chapter 2, paragraph 23 (Instrument Panel Mounting). Installed per PS Engineering *Installation Operators Manual* p/n 200-971-(XXXX), revision (    ), dated (    ).

This unit is FAA-Approved under TSO C50c for audio amplifiers, and meets appropriate environmental qualifications outlined in RTCA DO-160D as appropriate or this aircraft.

Interface to existing aircraft radios in accordance with installation manual and in compliance with practices listed in AC43.13-2, Chapter 2. All wires are Mil-Spec 22759 or 27500. Connection to aircraft dimmer bus is                     . Power is supplied to the unit through a     A circuit breaker (type and part number), and total electrical load does not exceed     % of the electrical system capacity with the PCD7100 added.

Aircraft equipment list, weights and balance amended. Compass compensation checked. A copy of the operation instructions, contained in PS Engineering document 200-971-(    ), revision (    ), dated (    ), is placed in the aircraft records. All work accomplished listed on Work Order                     .

### 8.2 Instructions for Continuing Airworthiness, PCD7100s

Sample ICA Checklist for PS Engineering PCD7100s:

Section	Item	Information
1	Introduction	Installation of intercommunications system.
2	Description	Installation as described in manufacturer's installation manual referenced on FAA Form 337, including interface with other avionics audio as required.
3	Controls	See installation and operator's guide referenced on FAA Form 337.
4	Servicing	None Required
5	Maintenance Instructions	On Condition, no special instructions
6	Troubleshooting	In the event of a unit problem, place the unit into "off," "fail-safe" and/or "emergency" mode. This allows pilot communications using aircraft radios. Follow checkout instructions in the installation manual referenced on the FAA Form 337. For a specific unit fault, contact the manufacturer at (865) 988-9800 for special instructions.
7	Removal and replacement information	<u>Removal:</u> Using a 3/32" Allen-head wrench, carefully unscrew the locking screw located in the center of the unit. While turning the wrench CCW, gently pull on the EDGES of the bezel until the unit is free from the mounting tray. <u>Installation:</u> Engage the locking screw at the back. Turn the locking screw CW, while applying slight pressure to the edges of the bezel. Do not over tighten!
8	Diagrams	Not applicable
9	Special Inspection Requirements	Not Applicable
10	Protective Treatments	Not Applicable
11	Structural Data	Not Applicable
12	Special Tools	None
13	Not Applicable	Not Applicable
14	Recommended Overhaul Periods	None
15	Airworthiness Limitations	Not Applicable
16	Revision	To be determined by installer



## Appendix E RTCA DO160D/EUROCAE ED-14D Environmental Qualification Form Intercom/CD Player

Part Number: 1195 ( )

FAA TSO Number: C50c

Manufacturer: PS Engineering Incorporated 9800 Martel Road Lenoir City TN 37772

Conditions	Section	Conducted Tests
Temperature and Altitude	4.0	Equipment tested to CAT B1
Low Temperature	4.5.1	-55° C Storage, -20°C Low Operating
High Temperature	4.5.2	+85°C Storage, +70°C High Operating
In-flight Loss of Cooling	4.5.4	Not Applicable, no cooling required
Altitude	4.6.1	25,000' unpressurized
Decompression	4.6.2	Not Applicable
Overpressure	4.6.3	Not Applicable
Temperature variation	5.2	Equipment tested to Category C
Humidity	6.0	Equipment tested to Category A
Shock	7.0	Equipment tested to Operational test only
Operational	7.2	Equipment tested Category B
Crash Safety	7.3	
Vibration	8.0	Equipment tested to Category S R
Explosion	9.0	Category X, not tested
Waterproofness	10.0	Category X, not tested
Fluids Susceptibility	11.0	Category X, not tested
Sand and Dust	12.0	Category X, not tested
Fungus	13.0	Category X, not tested
Salt Spray	14.0	Category X, not tested
Magnetic Effect	15.0	Equipment tested to Category Z
Power input	16.0	Equipment tested to Category B
Voltage Spike	17.0	Equipment tested to Category B
Audio Frequency Susceptibility	18.0	Equipment tested to Category B
Induced Frequency Susceptibility	19.0	Equipment tested to Category B
Radio Frequency Susceptibility	20.0	Equipment tested to Category T
Radio Frequency Emission	21.0	Equipment tested to Category M
Lightning Induced Transient Susceptibility	22.0	Equipment tested to Category XXE2
Lightning Direct Effects	23.0	Category X not tested
Icing	24.0	Category X, not tested